



Electrical Management Products Catalog

2007

from
Durand & Associates



Panel Schedule Software Commercial and Industrial Load Calculations

SAVE DESIGN TIME

Panel 2007 is a full function design package that will simplify the time consuming task of preparing a panel schedule. The built-in math features of the program provide 100% accuracy in the calculation of loads.

AUTO CALCULATION

Simply input the connected load for each branch circuit and the program will compute the total wattage per phase.

FAULT CURRENT CALCULATIONS

The program will automatically calculate the available fault current at all panels, transformers, and subpanels.

AUTOMATIC TRANSFORMER SELECTION

Simply input the connected load for each branch circuit at the subpanel and the program will select the proper transformer size.

PRINTOUTS

The program prints out completed panel schedules, circuit directories, and load calculations. Printouts have been approved by the cities of Los Angeles, New York, Miami, Atlanta, Chicago, San Francisco, and other major metropolitan areas.



AUTOCAD

You may copy any of the printouts and paste them into AutoCAD.

FIELD INSTALLATION

Field installation is a snap because the panel schedule printout details the feeder size, conduit size, circuit breaker size, and circuit numbers. Panel 2007 also generates a circuit directory to place in the panel.

CODE COMPLIANT

Panel 2007 performs all calculations based on the 2005 NEC.

**This product may be
downloaded from
our web site.**

ORDERING INFORMATION

www.durandassociates.com

PANEL 2007 is a spreadsheet template program that runs in conjunction with Microsoft Excel for Windows.

P07U - Upgrade Version for registered users	\$ 125
P07 - Full Version for new users	\$ 225

Electrical Design Software Commercial and Industrial Load Calculations

FULL FUNCTION

This is a full function 1-Line calculation program that calculates the size of the main service and subpanels and also prints out a complete 1-Line drawing.



CODE REQUIRED DRAWINGS

The all new Section 215.5 of the 2005 NEC requires feeder drawings and load calculations. This program will automatically fulfill this NEC requirement.

EASY DESIGN

Designing an electrical distribution system has never been easier or faster. Simply input the loads for the various panels and the program will do the rest.

AUTO CALCULATION & SIZING

The program will automatically size all panels, transformers, conductors, conduit, and system grounds per 2005 NEC requirements.

FAULT CURRENT & VOLTAGE DROP

Many building departments also require both fault current and voltage drop calculations. This program will automatically fulfill this requirement.

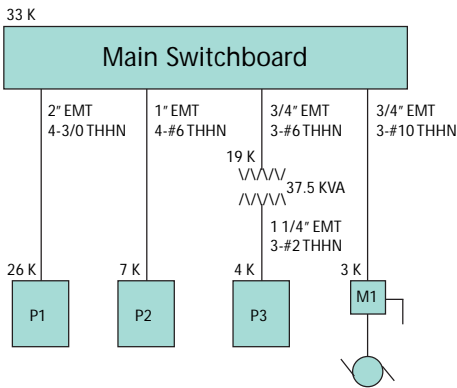

PRINTOUTS

The program prints out completed panel schedule, circuit directories, and load calculations. These printouts have been approved by the cities of Los Angeles, New York, Atlanta, Miami, Chicago, San Francisco, and other major metropolitan areas.

AUTOCAD

You may copy any of the printouts and paste them into AutoCAD.

This product may be downloaded from our web site.

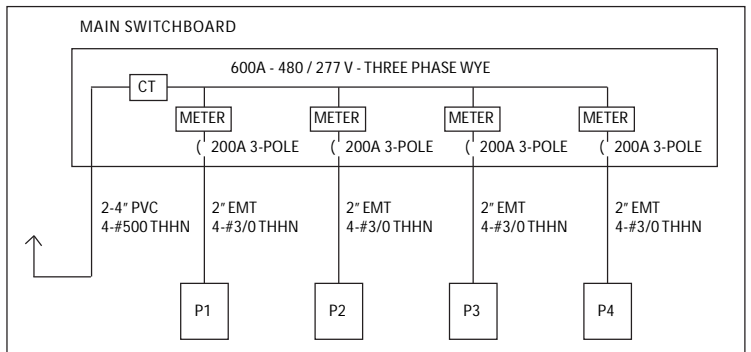

ORDERING INFORMATION

www.durandassociates.com

1-Line 2007 is a spreadsheet template program that runs in conjunction with Microsoft Excel for Windows.

1L7U - Upgrade Version for registered users \$ 175

1L07 - Full Version for new users \$ 395

Single Family Service Calculation Software

FULL FUNCTION

This full function residential service calculation program calculates the size of single family dwelling service in minutes.

Simply answer the multiple choice questions on the screen and the program calculates the minimum service size permitted by the 2005 National Electrical Code. With this program you will save hours of valuable time.



CODE REQUIRED DRAWINGS

The all new Section 215.5 of the 2005 NEC requires feeder drawings and load calculations. This program will automatically fulfill this NEC requirement.

AUTO CALCULATION

Simply input your information and the program will automatically size the service.

FAULT CURRENT CALCULATIONS

The program will automatically calculate the available fault current.

VOLTAGE DROP

The program will automatically calculate the voltage drop.

OPTIONAL CALCULATION

Load calculations are based on the optional calculation method from the 2005 NEC.

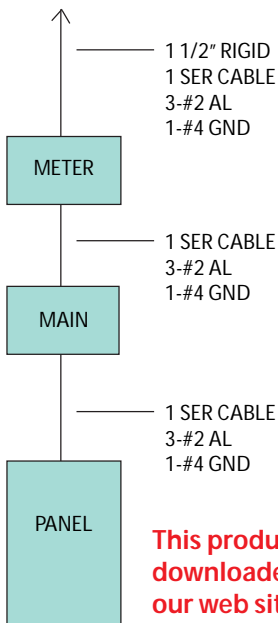

This product may be downloaded from our web site.



PRINTOUTS

All printouts are formatted like examples in the National Electrical Code. Program will print out a multi-page load calculation summary showing all calculations.

AUTOCAD

You may copy any of the printouts and paste them into AutoCAD.

FIELD INSTALLATION

Field installation is a snap because the printout details the feeder size, conduit size, and the main circuit breaker size.

ORDERING INFORMATION

www.durandassociates.com

SERVICE 2007 is a spreadsheet template program that runs in conjunction with Microsoft Excel for Windows.

S07U - Upgrade Version for registered users \$ 95

S07 - Full Version for new users \$ 185

Electrical Design Software Multifamily Dwelling Load Calculations

FULL FUNCTION

This is a full function 1-Line calculation program that calculates the size of a multifamily dwelling main service and prints out a 1-Line drawing.



PRINTOUTS

The program prints out completed 1-Line drawing and load calculations. These printouts have been approved by the cities of Chicago, Los Angeles, New York, Atlanta, San Francisco, Miami, and other major metropolitan areas.

AUTOCAD

You may copy any of the printouts and paste them into AutoCAD.



CODE REQUIRED DRAWINGS

The all new Section 215.5 of the 2005 NEC requires feeder drawings and load calculations. This program will automatically fulfill this NEC requirement.

EASY DESIGN

Designing a multifamily dwelling electrical distribution system has never been easier or faster. Simply input the loads for the various dwellings and the program will do the rest.

AUTO CALCULATION & SIZING

The program will automatically size all panels, transformers, conductors, conduit, and system grounds per 2005 NEC requirements.

FAULT CURRENT & VOLTAGE DROP

Many building departments also require both fault current and voltage drop calculations. This design program will automatically fulfill this requirement.

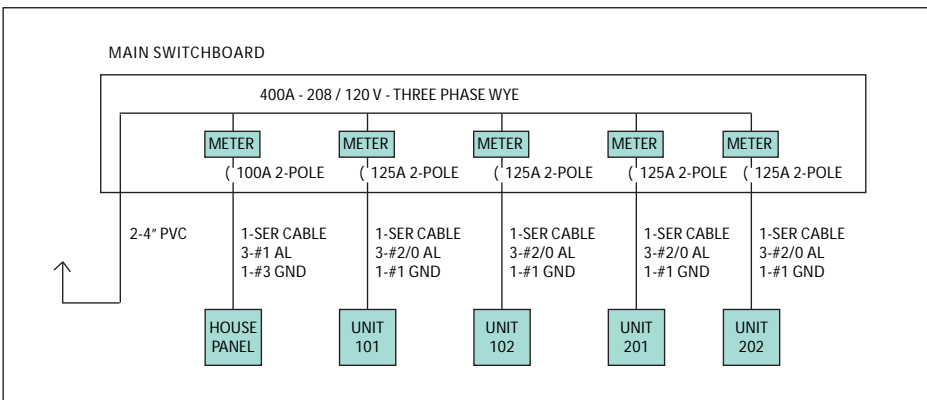

This product may be downloaded from our web site.

ORDERING INFORMATION

www.durandassociates.com

Residential 1-Line 2007 is a spreadsheet template program that runs in conjunction with Microsoft Excel for Windows.

1R7U - Upgrade Version for registered users \$ 150

1R7 - Full Version for new users \$ 325

Double Click Electrical Estimating Software

FEATURES

- Windows Compatible
- Mouse Compatible
- Point and Click Pricing
- 26,000 Part Database
- Price Updates 4 Times/ Year
- Free Price Updates (1 Year)
- Unlimited Assemblies
- Unlimited Pricing Sheets
- Permit Cost Worksheet
- Auto Crew Size Calculation
- Average Labor Rate Calculation
- Easy Pulldown Menus
- Free Telephone Support
- Vendor Quotation Worksheets
- NECA Format Pricing Sheets
- Standard Recap Sheet
- List of Outgoing Bids
- Scope of Work
- List of Exclusions
- Proposal Worksheet



PUT AWAY THE CALCULATOR

Let Double Click perform all the math calculations for you.



STANDARD FORMAT

This entire program is based upon standard pricing sheets commonly used in the industry. Your present familiarity with this format makes this software that much quicker to learn and easier to use. Simply enter the data in the same place you would if you were doing it manually!

ASSEMBLIES

With Double Click, you can estimate all or a portion of the work using assemblies. Any assembly may be changed or modified. Assemblies may be stored on your hard drive so they can be used on the next estimate.

MATERIAL ITEMS

Double Click allows you to estimate electrical work by entering the total material quantities. The program automatically calculates labor and material cost. The user may modify or change any material price or labor unit.

BEST OF BOTH WORLDS

With Double Click, you may estimate work using both the assembly and material item methods of estimating.

MORE THAN ONE COMPUTER

You may install Double Click on more than one (1) computer. Install copies on your office computer, your home computer, and/or your laptop. You may transfer files between computers using a Network, Email, or CD.

FREE PRICING SOFTWARE

With your purchase of the Double Click, you will automatically receive a FREE one year subscription to the Pricing & Labor Software. After the first year you may subscribe for pricing updates for \$300 per year. For additional details on the pricing database, turn to page 8 of this catalog.

PULLDOWN MENUS - NO TYPING REQUIRED

The program allows you to select material items from pulldown menus so there is no need to type in a part code. Once the desired item has been selected the material description, price, and labor unit are automatically placed on your pricing sheet. This eliminates the need to type in the material description.

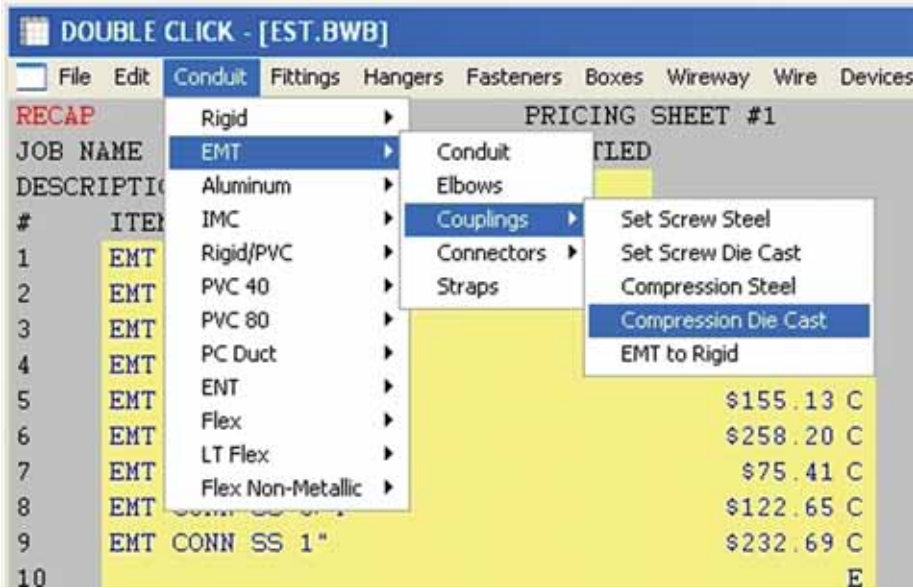

LIGHTING QUOTATIONS

Input fixture prices (per each) from each lighting vendor, and the program calculates the total for each vendor then forwards the lowest quotation to the recap sheet. You may also input a lump sum price.

POWER QUOTATIONS

Simply input the power quotations from each vendor and the program forwards the lowest quotation to the recap sheet. The program is designed to take all quotations just before bid time.

MISCELLANEOUS QUOTATIONS

The program allows you to create up to eight (8) categories of miscellaneous quotations. Each category may have up to six (6) vendors.

PROJECT INFORMATION

You may list the names of the owner, architect, and engineers. You may also list the bidding documents used in the preparation of the estimate (i.e. plans and specifications).

ORDERING INFORMATION

DC Double Click Electrical Estimating Software	\$895
DCD Double Click Demo CD-ROM	FREE

ADDING ITEMS ON THE FLY

At any time, you may add an item not found in the database by simply typing in the description, price, and labor unit.

HARDWARE REQUIREMENTS

Double Click is a stand alone program designed to run on Windows based operating systems. The Double Click program is compatible with all Windows systems.

LIST OF OUTGOING BIDS

You may make a list of outgoing bids including the name of the company, time & date of bid, and the price quoted to each company.

AVERAGE LABOR RATE CALCULATION

Double Click will automatically calculate your average labor rate.

FREE TELEPHONE SUPPORT

Unlike our competitors who charge for support, we offer FREE SUPPORT on an ongoing basis year after year.





Pricing & Labor Software

COMPUTER PRICING

With just a touch of the fingertips access over 26,000 prices and labor units.



ESTIMATE SHEET

For a small estimate or change order simply use the built-in pricing sheet to compile an estimate.

TRADE PRICES

The prices in the program are "trade prices" and are updated (via internet or CD) four (4) times per year. You may assign a discount to any price or category to arrive at an adjusted price. You may also input your actual cost for any item. The Pricing & Labor Software contains all of the items listed in the Trade Price Book. (See Page 15)

LABOR UNITS

In addition to trade prices the program also contains labor units for over 26,000 items. You may adjust these labor units up or down; or, if you wish, you may input your own labor units. The Pricing & Labor Software contains all of the labor units listed in the Labor Units Manual. (See Page 10)

PRICE UPDATES

Prices are updated four (4) times per year (December, April, August and October). Each time prices are updated, you will automatically receive a CD with updated trade prices.

ORDERING A SUBSCRIPTION

The Pricing & Labor Software is a subscription service program and may only be used by current subscribers. The cost of the service is \$300.00 per year.

PLW \$300

FEATURES

- Overcurrent Protection
- Short Circuit Calculation
- Component Protection
- Selective Coordination
- Series Combination Rating
- Fault Current
- Transformer Fault Current
- AutoCad Copy Paste

Short Circuit Software



FULL FUNCTION

This full function short circuit calculation program will help you comply with 2005 NEC.

Short Circuit performs all calculations per the requirement of the 2005 National Electrical Code and industry standards.

ORDERING INFORMATION **This product may be downloaded from our web site.**

Short Circuit is a spreadsheet template program that runs in conjunction with Microsoft Excel for Windows.

SC07 - Full Version for new users \$ 180

Labor Units Manual

TAKE THE GUESS WORK OUT OF ESTIMATING

Just a touch of the fingertip accesses labor units for over 26,000 items. These labor units are realistic and competitive and will prove to be of great value to any organization. It will also provide you with realistic labor units that will help you determine how many man-hours are required for a given task. These labor units are time proven and are used by electrical contractors throughout the country. This manual has tabs for easy use, plus a cross reference index.

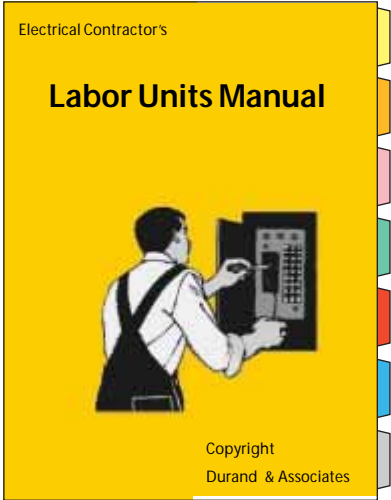

LABOR UNITS FOR 26,000 ITEMS

The labor units in this manual were developed over a period of twenty years using actual job cost records of various contractors.

BOOK Tabbed for easy use.

CD Complete book on CD PDF file format.

BIDDING IT RIGHT!

The labor units in this manual are very competitive. This means your prices will be competitive.

DON'T LEAVE MONEY ON THE TABLE

Many electrical contractors bid work too cheaply because they do not know how to properly estimate labor hours. With the Labor Units Manual, you can bid it right the first time.

CERTIFIED ESTIMATING

The Labor Units Manual was written by Gary P. Durand, Certified Professional Estimator with the American Society of Professional Estimators. Mr. Durand has taught electrical estimating for both the National Electrical Contractors Association (NECA) and California State University San Jose.



The most complete labor manual in the industry



This product may be downloaded from our web site.

ORDERING INFORMATION

www.durandassociates.com

L06 (BOOK)	\$125
LD06 (CD)	\$ 95
LC06 (BOOK & CD)	\$145



Trade Price Book

In addition to the standard contractor's prices (trade prices), this guide also lists various discount prices that are available within the industry. The Trade Price Book is updated in December, April, August and October. Each update reflects the current pricing levels at the time of publication. Included with your purchase are three additional price updates. Updated pricing sheets will be sent to you at no additional cost. After the first year, you may purchase updated pricing sheets for \$225 per year.

TPB \$245

Estimating Electrical Construction

A step-by-step guide to estimating electrical work, the guide walks you through the estimating process from beginning to end. Included are: bidding procedures, take off, material pricing, labor costing, specifications, change orders, and project management.

EEC \$60

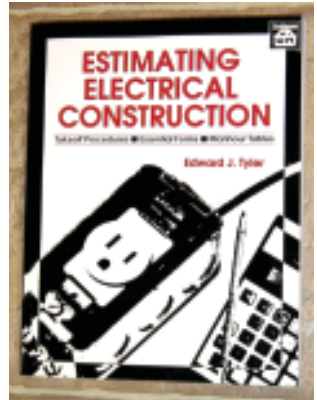

ORDER PROCESSING

NEXT & 2ND DAY ORDERS MUST BE RECEIVED BY 10 AM PST.
ALL OTHER ORDERS ARE SHIPPED THE FOLLOWING DAY.

- SHIPPING CHARGE GROUND (\$ 10)
- SECOND DAY AIR SHIPPING CHARGE (\$ 20)
- NEXT DAY AIR SHIPPING CHARGE (\$ 40)

The standard method of shipment is US Mail 4th Class.
UPS ground service is available upon request.

Approximate "Working Days" Delivery Time

DURAND & ASSOCIATES
176 THREE WATERS ROAD
PRIEST LAKE, ID 83856

Phone (208) 443-6627
Fax (208) 443-6629

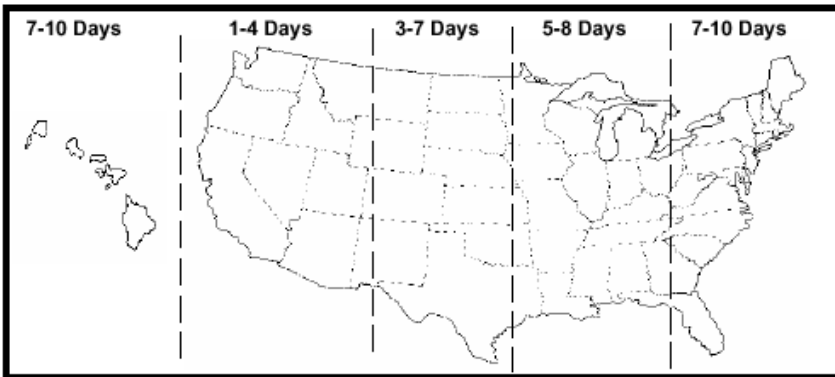

RETURN POLICY

You may return any book and the Pricing & Labor Software to our office within 30 days of the shipment date for a full refund, less shipping and handling charges. All sales of Estimating Forms and Software Products are final and may not be returned for a refund.

Design/Build Guide

FAST & EASY DESIGN

Project planning and designing has never been easier or faster! Complicated and time consuming NEC references and calculations are all listed in an easy to read format.

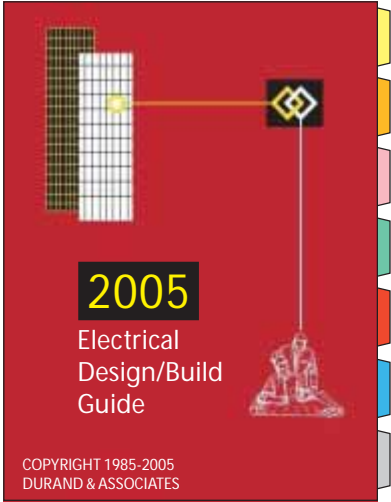

SAVE TIME & MONEY

This guide will pay for itself the first time you use it. You will wonder how you got along without this valuable resource.

BOOK Tabbed for easy use.

CD Complete book on CD PDF file format.



BOOK SECTIONS INCLUDE

- Motor Schedules
- Conduit Fill
- Equipment Ground
- Conduit Sizing
- Short Circuit
- Switch Sizes
- Load Calculations
- Panel Schedules
- Fuse Sizes
- Grounding
- Transformer Schedules
- Breaker Sizing
- Voltage Drop Graphs
- Lighting Layouts

PUT AWAY YOUR CALCULATOR!

The Design/Build Guide enables the user to save countless hours in the electrical design process by illustrating tens of thousands of calculations and configurations. Just the touch of your fingertip quickly accesses over 900 motor configurations, more than 5,000 voltage drop possibilities, over 7,000 load calculations, and much, much more. Additionally, the book is tabbed for even quicker reference and is spiral bound to make it lie flat and easy to read.

DON'T JUST TAKE OUR WORD FOR IT!

Now in it's 21st year of existence and 35th printing, demand for the Design/Build Guide continues to grow larger. Throughout the world, engineers, contractors, Fortune 500 companies, government agencies and universities continue to applaud the merits of this manual.



PROPER DESIGN

There is no substitute for proper design. Poor design leads to cost overruns, delayed completion time, Code violations, and dissatisfied clients. With the Design/Build Guide you will get the design right the first time. Clients will be impressed and more likely to use your services in the future.

This product may be downloaded from our web site.

ORDERING INFORMATION

www.durandassociates.com

DB05 (BOOK)	\$125
DD05 (CD)	\$ 95
DC05 (BOOK & CD)	\$145

Smart Forms 2007

The electronic version of our standard forms.

FEATURES

- Pricing Sheets
- Recap Sheets
- Branch Circuit Take-Off
- Conduit & Wire Take-Off
- Feeder Schedules
- Residential Estimate & Take-Off
- Job Cost Labor Sheets
- Job Cost Material Sheets



FULL FUNCTION

These full function electrical estimating forms calculate totals with 100% accuracy. Smart Forms 2007 automatically performs all calculations and provides a format consistent with good business practices.

PRINT BLANK FORMS

You may print blank or completed forms.

This product may be downloaded from our web site.

ORDERING INFORMATION

www.durandassociates.com

SMART FORMS 2007 is a spreadsheet template program that runs in conjunction with Microsoft Excel for Windows.

SF07 - Windows Excel Version \$ 79

Electric Math 2007

Use your computer to calculate all those complex formulas for commercial, residential, and industrial work.

FEATURES

- Voltage Drop
- Power Factor
- Transformer Sizing
- Box Fill
- Conduit Fill
- KVA, KW, AMPS, VOLTS

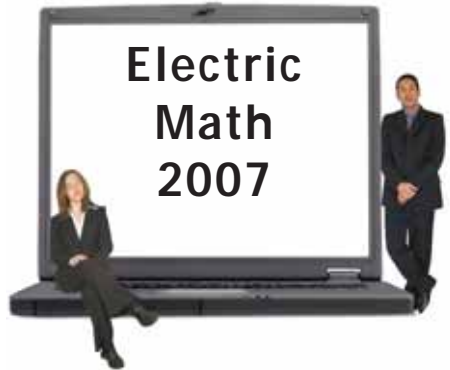

**Phone Orders Call
(208) 443-6627**

This product may be downloaded from our web site.

ORDERING INFORMATION

www.durandassociates.com

ELECTRIC MATH 2007 is a spreadsheet template program that runs in conjunction with Microsoft Excel for Windows.

EM07 - Windows Excel Version \$ 79

Journeyman Electrician's Review

Fully updated based on the 2005 edition of the National Electrical Code. This all inclusive Journeyman Electrician's Review provides users with a proven effective way of preparing for and passing professional licensing exams. Includes three comprehensive practice exams.

JE\$59

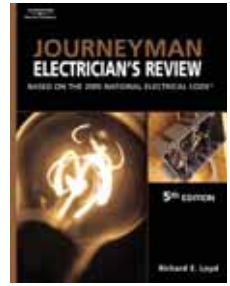

Master Electrician's Review

The success-proven Master Electrician's Review has been greatly expanded and updated based on NEC 2005 to provide journeyman electricians with a clear-cut route for acquiring all of the knowledge and professional expertise they need to become licensed master electricians. New realistic practice exams plus a math refresher to update readers' skills in working with fractions, decimals, square roots and powers are just the beginning.

ME\$54

Interpreting The National Electrical Code

Extraordinarily comprehensive, this book is completely updated to the 2005 National Electrical Code and continues to offer valuable insight into the Code articles. Explanations are provided for each article in detail, with thorough discussions and practical examples that clearly illustrate how the Code and its most recent changes are applied.

ITP\$52

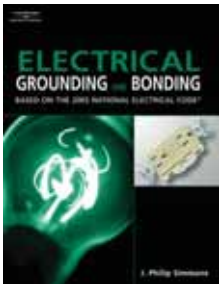
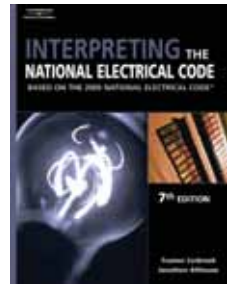

Electrical Grounding

Written in accordance with the 2005 National Electrical Code, this new book provides readers with a comprehensive introduction to the essential elements of electrical grounding and bonding. It examines the critical concepts of calculating conductor sizes, reading and interpreting NEC tables, the use of grounded conductor connections in DC and AC systems, as well as various installations and sizing.

EG\$59

Residential Wiring

Completely updated to include changes to the 2005 National Electrical Code NEC, this newly revised edition examines dwelling unit electrical power and lighting wiring for the installer, as well as anyone else interested in the rules and methods for residential wiring. Coverage takes readers through the construction of a typical suburban house.

RW\$78

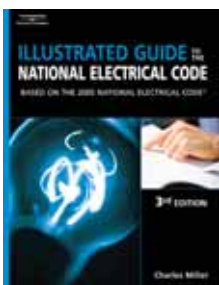
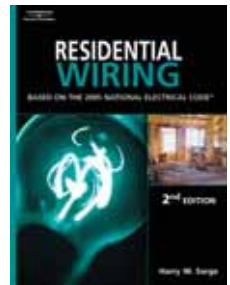

Illustrated Guide to the National Electrical Code®

Over the years, the National Electrical Code has grown in volume and complexity. This updated edition utilizes visualization to present a complete, concise, and easy-to-understand exploration of the 2005 Edition of the NEC that is unlike anything available on the market today.

IG\$68

ORDER FORM - J07

Fax (208) 443-6629

Phone (208) 443-6627

COMPANY NAME _____

ADDRESS _____

CITY _____ STATE _____ ZIP _____

PHONE _____

ATTENTION _____

EMAIL ADDRESS _____

ITEM	PAGE	DESCRIPTION	QTY	PRICE EA	TOTAL

SUB TOTAL \$ _____

SALES TAX (IDAHO RESIDENTS ONLY ADD 6%) \$ _____

SHIPPING CHARGES - Ground \$10, 2-Day \$20, Next Day \$40 \$ _____
(Download & Email delivery at no extra charge)

TOTAL \$ _____

CHECK OR PO ENCLOSED

VISA MASTERCARD

AMX DISCOVER

SORRY NO COD ORDERS

MAIL ORDERS TO
DURAND & ASSOCIATES
176 THREE WATERS ROAD
PRIEST LAKE, ID 83856

NAME _____

CARD # _____

EXP. DATE _____

SIGNED _____